

アナログのチカラ



2020 Energy Conservation Grand Prize
Product & Business Model Category

**"ECCJ Chairman's Award" of
"2020 Energy Conservation Grand
Prize/Product & Business Model Category"**
**Ultra-low Power Consumption,
Small Step-down DC/DC Converter
XC9276 series**

TOREX SEMICONDUCTOR LTD.

1. Smaller battery capacities in association with smaller electronic device sizes.
2. Reduced frequency for charging of electronic devices, and longer continuous operating times.
3. Changes in operating voltage of chipsets used in electronic devices.

【Specification Power Supply Voltage Ranges of Newest Communication Chipsets】

PARAMETER	SYMBOL	MIN	TYP	MAX	UNIT
Supply Voltage for Core Block	V core	0.65	-	1.1	V
	Sleep mode	0.65	0.7	0.75	V
	Active mode	0.9	1.0	1.1	V

Input voltage range for Sleep mode

Input voltage range for Active mode

Reductions in power consumption are advancing as chipsets change power supply voltages according to operating mode.

Product Concept ②: Status of chipsets used in electronic devices

Reductions in power consumption are advancing as chipsets change power supply

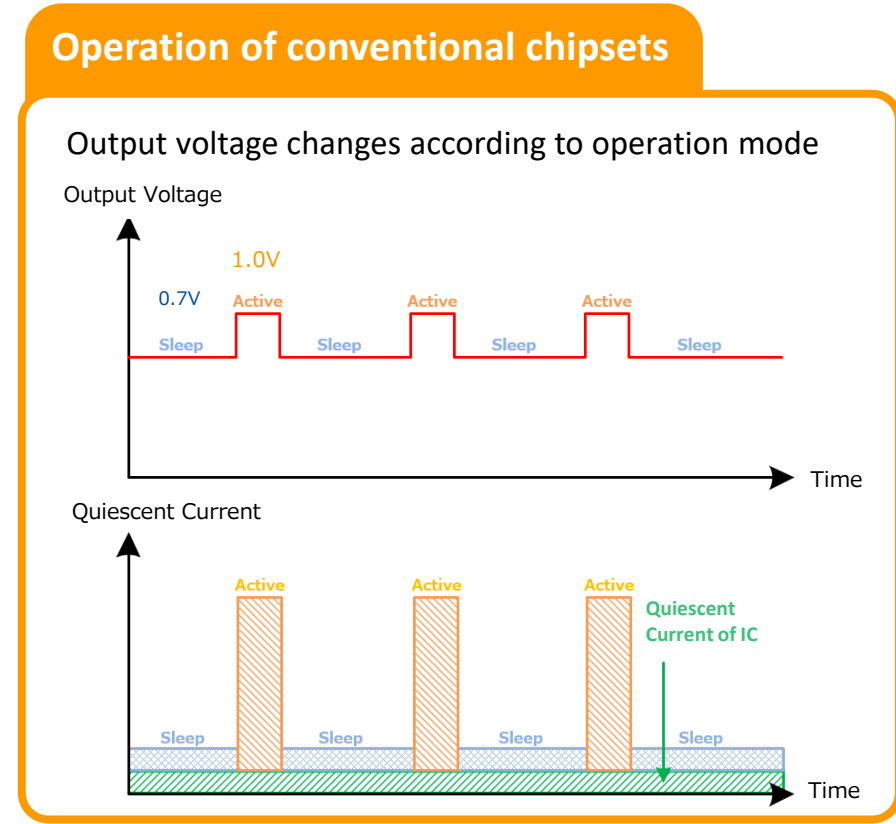
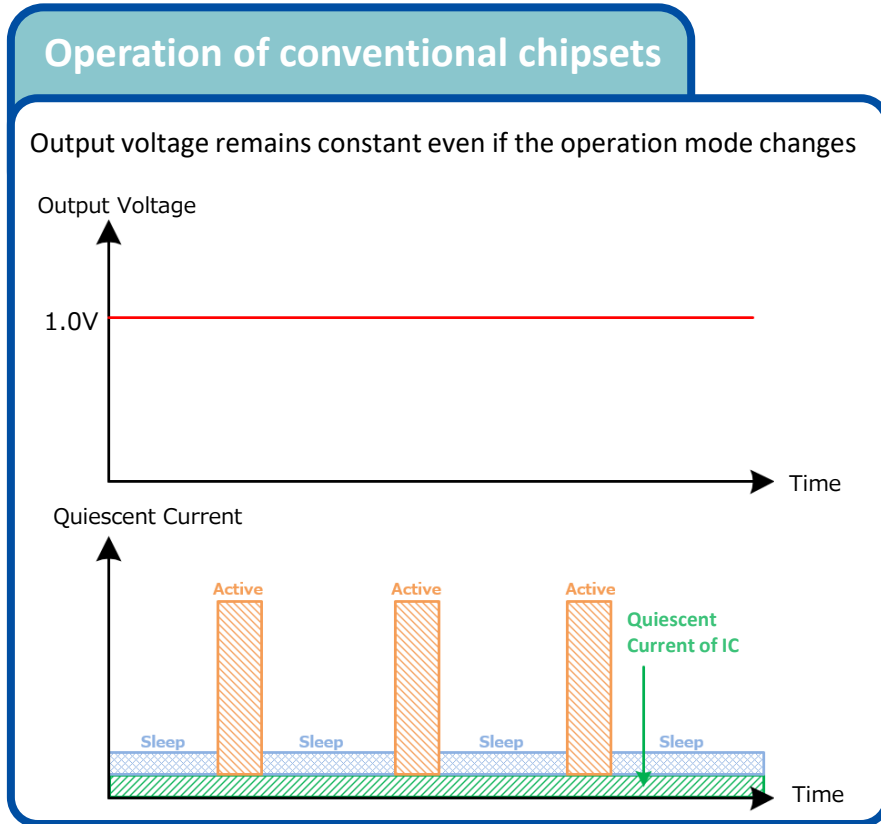

- Power supply ICs that can switch the output voltage to match the chipset operation mode are required.
- During Sleep mode (= low quiescent current), most of the losses are determined by the quiescent current of power supply ICs.

DC/DC converters are a significant factor for greater energy conservation.

Market Trends

1. Smaller battery capacities in association with smaller electronic device sizes.
2. Reduced frequency for charging of electronic devices, and longer continuous operating times.
3. Changes in operating voltage of chipsets used in electronic devices.



Market Requirements

1. Achievement of Ultra-low Quiescent Current
2. Output Voltage Switching Function (V_{SET} Function)
3. Smaller Mounting Areas

The functions indicated at the left will be explained next page.

Product Features ①: Achievement of ultra-low quiescent current

Ultra-low quiescent current is achieved by **stopping internal circuits** in accordance with the IC control conditions, to **reduce the quiescent current** compared to conventional products.

Issues for Stabilization of Reference Values and High-speed Response

Issue①

Stable operation is required even during internal circuits are stopped.

Issue②

High speed is required for rise-up from the state where internal circuits are stopped to their operating state.

Methods for Stabilization of Reference Values and High-speed Response

Method①

Design new circuits which can achieve stable operation even during circuits are stopped.

Method②

Shorten the rise-up time by creating new, original circuits.

Effects of Low Quiescent Current

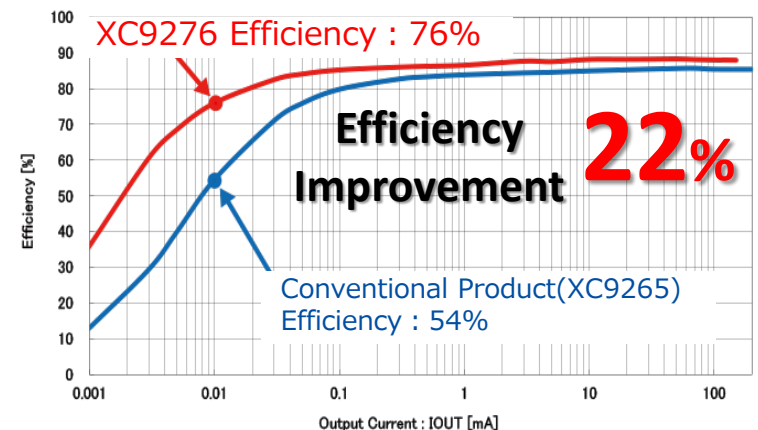
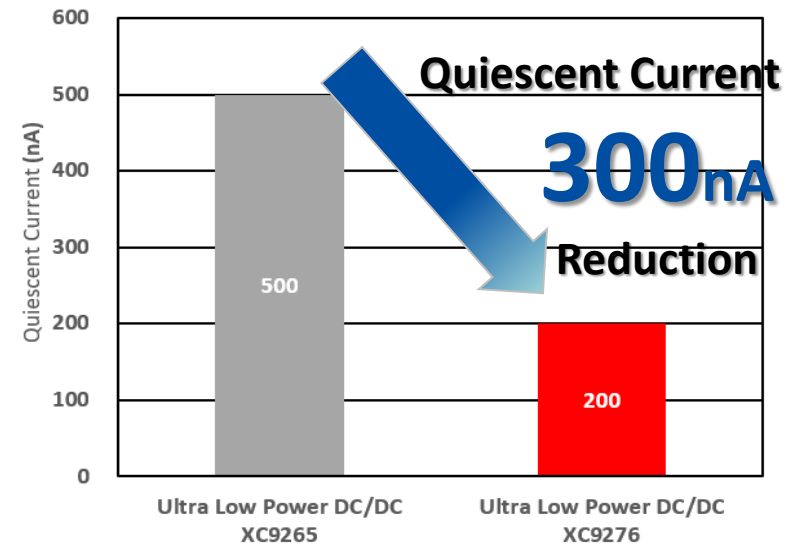

Product Feature ②: Output Voltage Switching Function (V_{SET} Function)

A new function has been realized which can switch between binary output voltages with no need for external parts, using only input signals.

General methods for Switching Output Voltages

① Switching by using changes in external resistance values

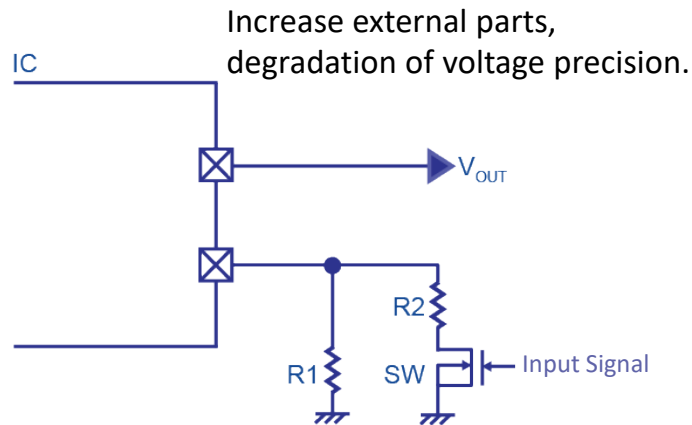

② Switching by using multiple setting pins

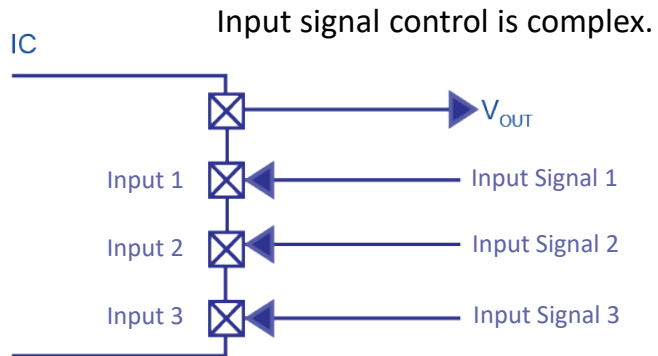

Methods for Switching Output Voltage in XC9276 Series

① Output voltage setting resistance is internal to the IC

No need for external resistances

Achieve Higher Precision \Rightarrow Apply Trimming Technology

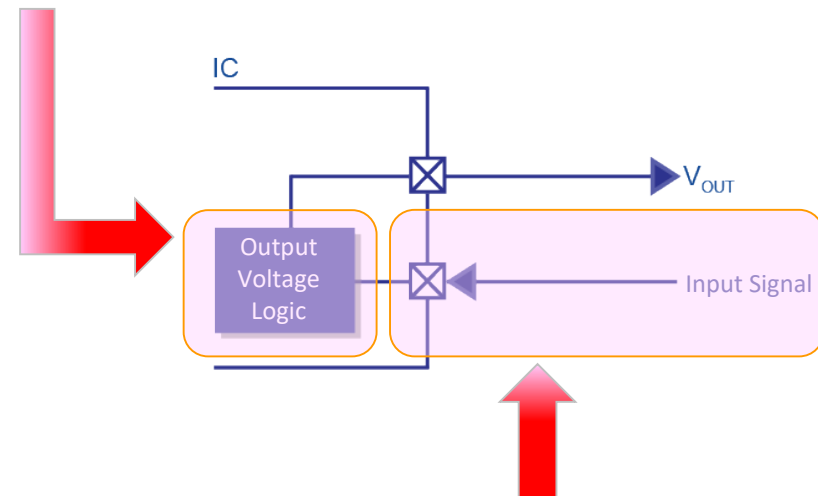

② Binary output voltages are output by input signals

Simple control

No constraints on output switching

Product Features ① + ②: Effects of Ultra-low Quiescent Current and Output Voltage Switching Function

Energy saving effects are achieved due to **reduction of quiescent current** and **output voltage switching function**.

Efficiency Graph of XC9276 Series

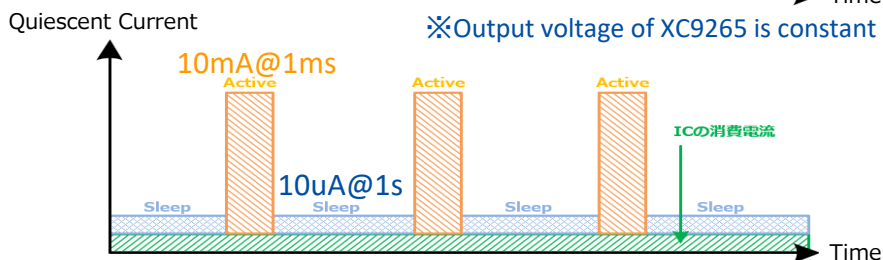
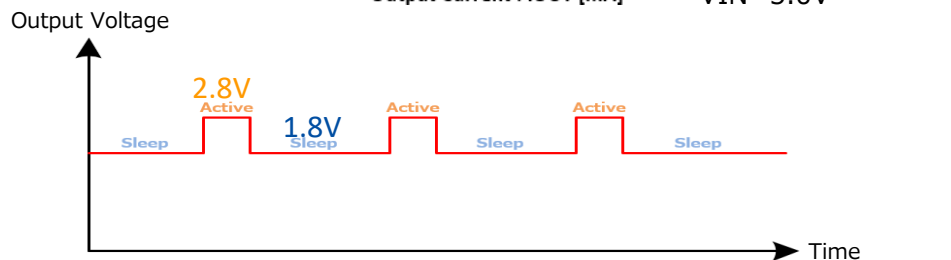
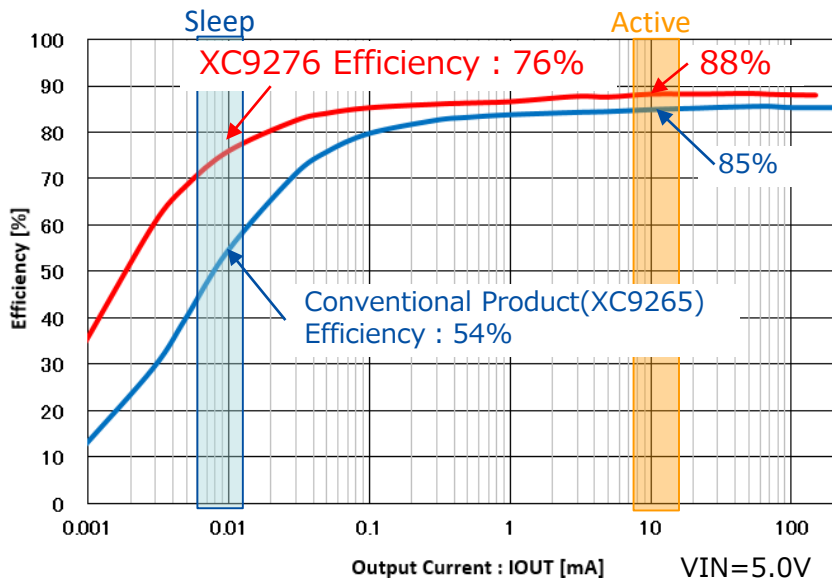

Energy Saving Effect

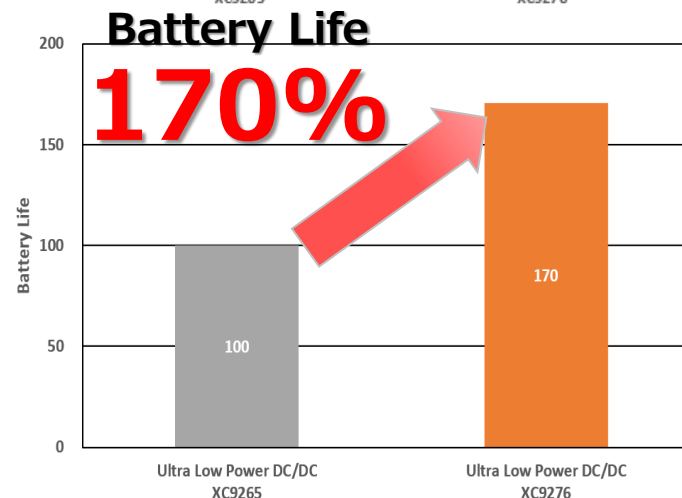
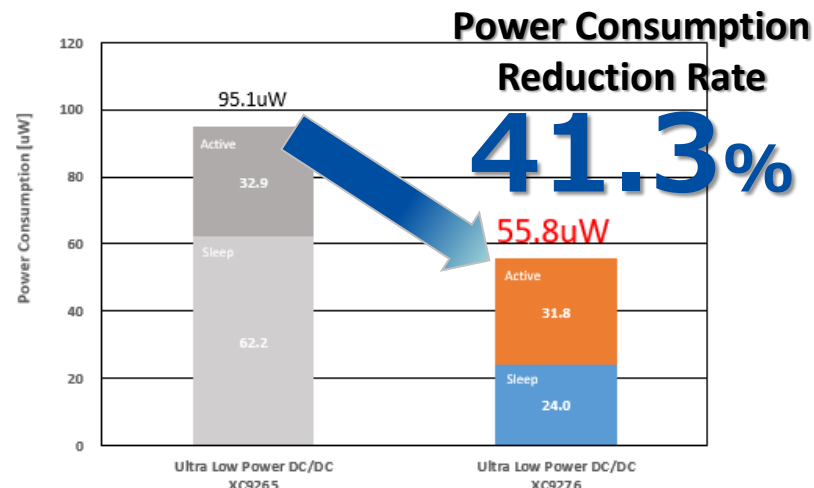

※Comparison with XC9265 as a value of 100.

Product Feature③: Smaller mounting areas

Reduction in mounting areas is achieved by the coil inductance value and reducing the IC package size.

Issues for Reducing Coil Sizes

Coil Current Waveform

— : L = 2.2μH
— : L = 10μH

Ideal Operation

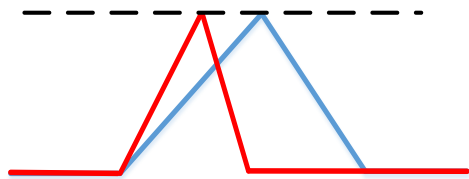

Actually...

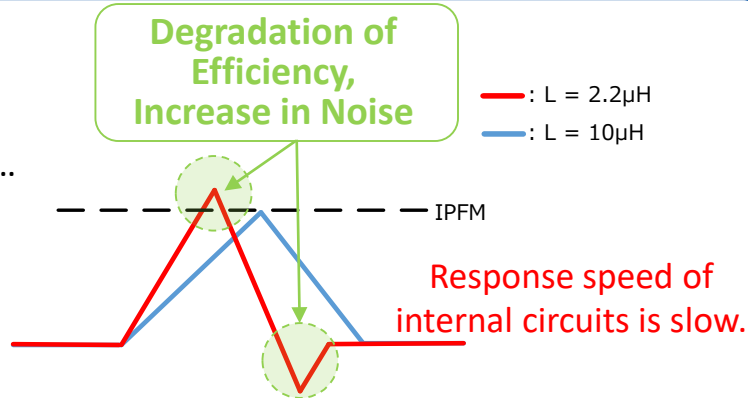

Since the slope of the coil current increases, there is a need to also increase the response speed of internal circuits.

Reductions in Mounting Area

Mounting Area Reduction Rate

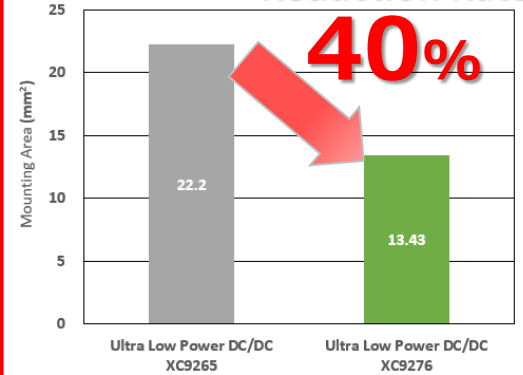

Method for Reducing Coil Sizes

Coil Current Waveform

【Before】

Degradation of Efficiency, Increase in Noise

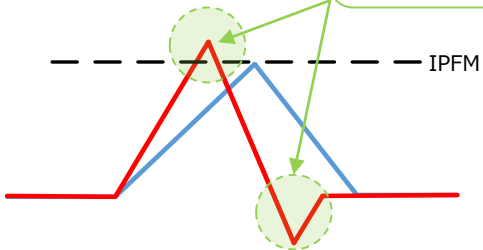

【After】

Significant Improvement

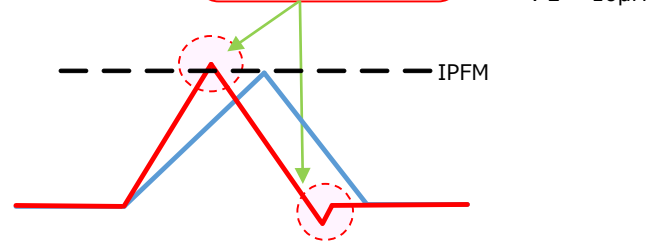

With consideration for the trade-off between response speed and quiescent current, a response speed is used which does not adversely affect the ultra-low consumption.

XC9276

Package : WLP-6-03
1.72 x 1.07 x 0.33mm

Coil : 2.2uH
2.0 x 1.6 mm

XC9265

Package : USP-6EL
2.0 x 1.8 x 0.4mm

Coil : 10uH
3.0 x 2.5 mm

Greater energy saving properties are achieved by product features ① low current, and ② voltage switching. Smaller spaces are achieved by product feature ③.

Energy Saving of XC9276 Series

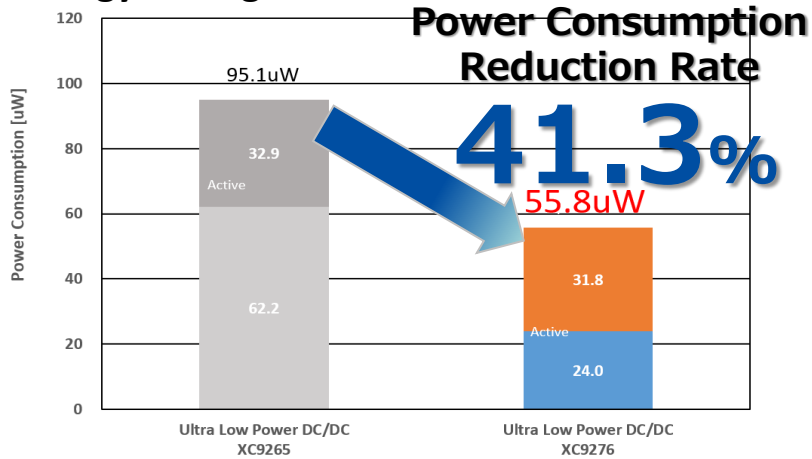

Space Saving of XC9276 Series

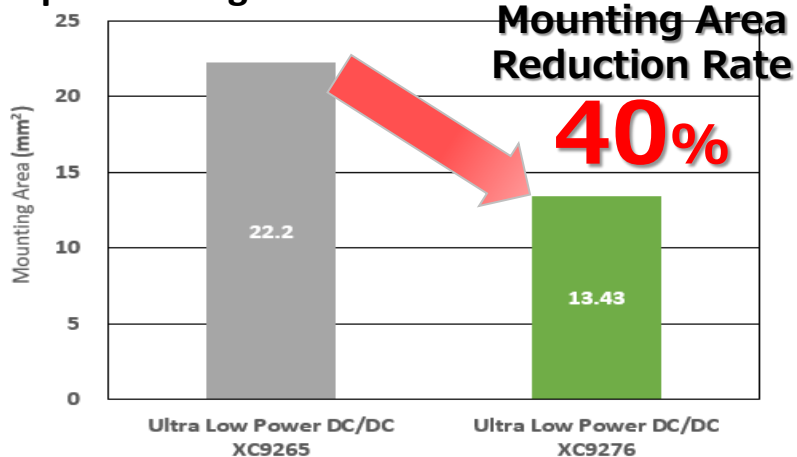

Effects from use of XC9276 Series

① Reduction Rate of Battery Capacity

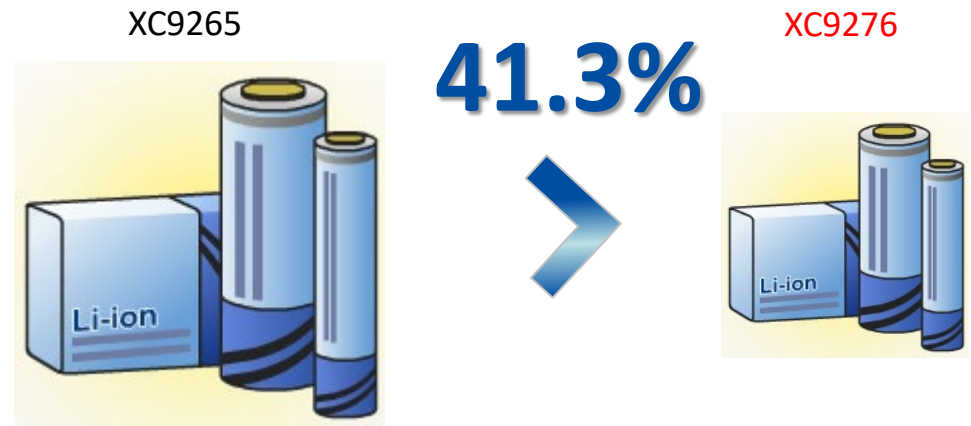

② Reduction Rate of Board Sizes

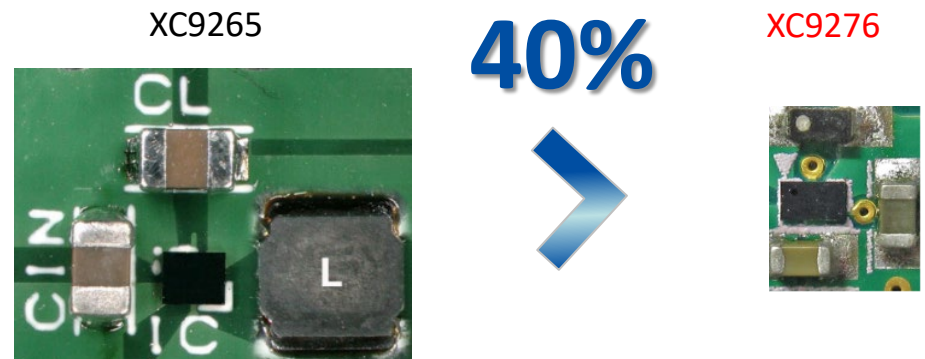

The XC9276 series can greatly contribute to achieving smaller sizes and lower power consumption for electronic devices.